

Vertically adjustable material support with roller guidance for rotating and stationary pipe and solid material. For trade and industry. For the building site and the workshop.

Pipes, solid material \varnothing (1/8) 3/4 – 6", \varnothing (6) 26 – 168 mm
Load capacity \leq 150 kg

REMS Herkules – the sturdy support.

Easy moving of the material in all directions when turning, pulling and pushing by two stainless steel balls mounted in a rust-protected housing in the range \varnothing 3/4 – 6", \varnothing 26 – 168 mm.

Especially suitable for pipe installation, e.g. for cutting, thread cutting, roll grooving, welding, soldering.

Robust, job site-proven design. Dismantles for transport and stocking.

Optionally on safe standing tripod or with clamping device for workbench.

Height adjustable, REMS Herkules 3B from 690 to 1,180 mm from the floor, REMS Herkules Y from 35 to 580 mm from the workbench surface.

Supply format

REMS Herkules. Vertically adjustable material support for pipes, solid material \varnothing (1/8) 3/4 – 6", \varnothing (6) 26 – 168 mm. Optionally on tripod or with clamping device for workbench. Load capacity \leq 150 kg. In a carton.

Description	Version	Art.-No.	€
REMS Herkules 3B	Tripod with protection caps	120120R	334,24
REMS Herkules Y	Clamping fixture for work bench	120130R	201,37



German Quality Product



Info

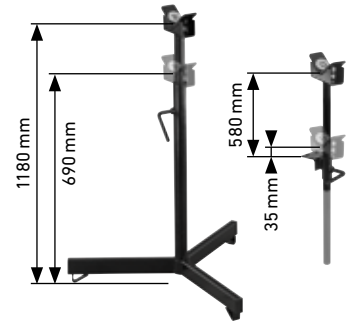

Height adjustable material support with ball guide for rotating and standing tubular and solid material. For trade and industry. For the building site and the workshop.

Pipes, solid material \varnothing (1/8) 1 1/4 – 12", \varnothing (6) 42 – 324 mm
Load capacity \leq 450 kg

REMS Herkules XL 12" – extra stable for pipes up to 12".

Especially suitable for pipe installation, e.g. for roll grooving, cutting, thread cutting, welding, soldering.

Easy moving of the material in all directions when turning, pulling and pushing by two stainless steel balls mounted in a rust-protected housing in the range \varnothing 1 1/4 – 12", \varnothing 42 – 324 mm.

Robust, job site-proven design. Securely standing tripod, folds up for transport and storage.

Height adjustable from 505 to 915 mm from the floor.

Threaded spindle for simple alignment of the pipe, with fixing device.

Practical handle for easy transport.

Supply format

REMS Herkules XL 12". Height adjustable, fold-up for pipes, solid material \varnothing 1 1/4 – 12", \varnothing 42 – 324 mm. Load capacity \leq 450 kg. In a carton.

	Art.-No.	€
	120125R	362,26

