

Robust, mobile compact machine. Universal for cutting pipes. For trade and industry. For the building site and the workshop.

Stainless steel pipes of pressfitting systems, carbon steel, copper	Ø 54–225 mm
Steel pipes EN 10255 (DIN 2440)	DN 40–150 Ø 1½–6"
Cast iron pipes (SML) EN 877 (DIN 19522)	DN 50–200
Plastic pipes SDR 11	
Wall thickness $s \leq 21$ mm	Ø 40–225 mm
Multilayer composite pipes	Ø 40–110 mm

REMS DueCento – Cutting up to Ø 225 mm.
Right angled. Chip-free. Ready for welding. Fast.
No outer burr. Dry cutting.

Universal for many pipe types.

Right angled cutting, according to requirements
Chip-free, no chips in the pipe system, no dust
Weldable, for muff and butt welds
Fast, without impairment of the pipe material by overheating
Without outside burr, easy insertion into connecting muffs
Dry cutting, without impairment by coolant lubricants

Design

Compact, mobile pipe cutting machine for fast, right angled, cutting with no outer burr. Handy and easily transportable, only 37 kg. Stable, distortion-free cast construction for right angled cutting. Easy pipe-cutting through specially designed cutter wheel. Powered cutter wheel and linear advance for fast cutting (**Patent EP 1 782 904**). Power saving feed-in through easy to grip, proven advance-lever and needle bearing mounted machine screw spindle. Cutter wheel protected – as movement restricted to before any contact with the rollers. Practical chassis with two rubber tyred wheels for easy transport.

Running rollers

4 strong hardened precision tubular steel running rollers on ball bearings for low-friction turning of the pipes to be cut, arranged in convex square for centred thrust pressure of the cutting wheel in the working range Ø 100–225 mm, Ø 4–6", without setting work (**Patent EP 2 740 556**). Roller insert for cutting pipes Ø 40–110 mm, Ø 1½–4", as an accessory.

Drive

Robust gear, precisely mounted in roller and needle bearings, maintenance-free. Proven universal motor, 1200 W. Powerful, e.g. plastic tube PE Ø 225 mm in just 15 s. Ideal speed 115 rpm for optimum cutting speed of the pipes. Safety foot-switch with emergency stop.

REMS cutter wheels

Top German quality. Cutter wheels specially designed to the performance capability of the REMS DueCento and for numerous pipe materials with variable cutting geometries for fast cutting with no outer burr. Specially hardened, from proven, through-hardened REMS die-steel, ensuring long service life.

Pipe supports

Pipe supports, height adjustable, for pipes Ø 40–110 mm, Ø 1½–4" and Ø 100–225 mm, Ø 4–8". Easy moving of the material in all directions when turning, pulling and pushing by four stainless steel balls mounted in a rust-protected housing. Safe guiding of long pipes by use of several pipe supports.

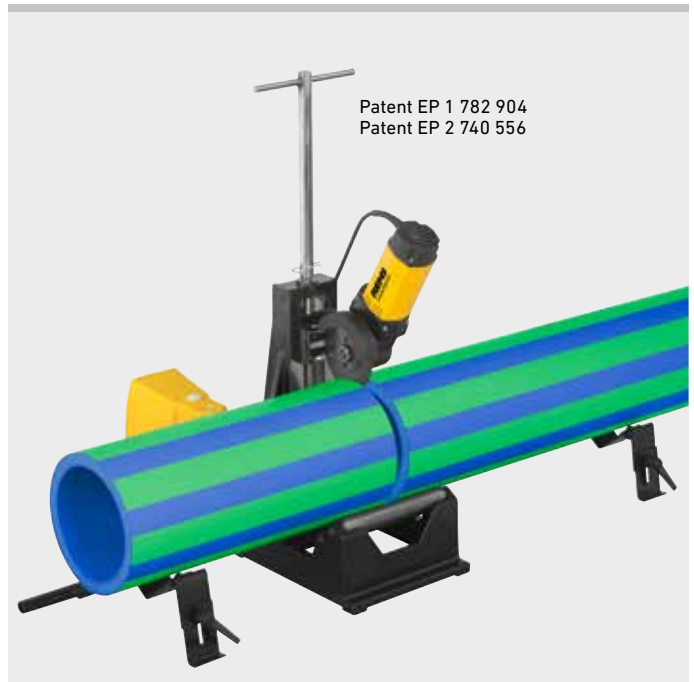

German Quality Product



Info



Supply format

REMS DueCento Basic. Pipe cutting machine for fast, right angled cutting of pipes Ø 40–225 mm, without outside burr. For pipes of the press fitting systems made from stainless steel, carbon steel, copper, Ø 54–225 mm. For steel pipes EN 10255 (DIN 2440) DN 40–150, Ø 1½–6", cast pipes (SML) EN 877 (DIN 19522) DN 50–200, plastic tubes SDR 11, wall thickness $s \leq 21$ mm, Ø 40–225 mm, Ø 1½–8", composite tubes Ø 40–110 mm. With maintenance-free gears, proven universal motor 110 / 230 V, 50–60 Hz, 1,200 W. Speed 115 rpm. Hardened, precision tubular steel rollers for pipes Ø 100–225 mm, Ø 4–6". Safety foot switch. Ring spanner. Without cutter wheel. 2 height adjustable pipe supports 1 for pipes Ø 100–225 mm, Ø 4–8". In a carton.

	Art.-No.	€
	845004R220	2 896,02

Other voltages on request.



Accessories

Description	Art.-No.	€
REMS cutter wheel Cu-INOX for stainless steel pipes of pressfitting systems, copper, carbon steel	845050R	111,07
REMS cutter wheel Cu specially for pipes of copper pressfitting systems	845053R	111,07
REMS cutter wheel St for steel pipes, cast iron pipes (SML)	845052R	111,07
REMS cutting wheel C-SF especially for pipes of the pressfitting systems and push fitting systems made from carbon steel, simultaneously produces a chamfer.	845055R	111,07
REMS cutter wheel V, s 10 for plastic and multilayer composite pipes, wall thickness $s \leq 10$ mm	845051R	111,07
REMS cutter wheel P, s 21 for plastic and multilayer composite tubes, wall thickness $s \leq 21$ mm	845057R	140,13
Pipe support 1 , height adjustable for pipes Ø 100–225 mm, Ø 4–8"	845220R	152,59
Pipe support 2 , height adjustable, for pipes Ø 40–110 mm, Ø 1½–4" (roller insert required)	845230R	152,59
Roller insert for cutting pipes Ø 40–110 mm, Ø 1½–4"	845060R	242,89

