

REMS Akku-Press XL 45kN 22V ACC

Teileverzeichnis

Aktueller Stand
siehe www.rems.de
weitere Teile auf Anfrage

Spare parts list

Latest version
see www.rems.de
other parts on request

Liste des pièces

Situation actuelle
voir www.rems.de
autres pièces sur demande

Elenco dei pezzi

Ultimo aggiornamento
vedi www.rems.de
altri ricambi su richiesta

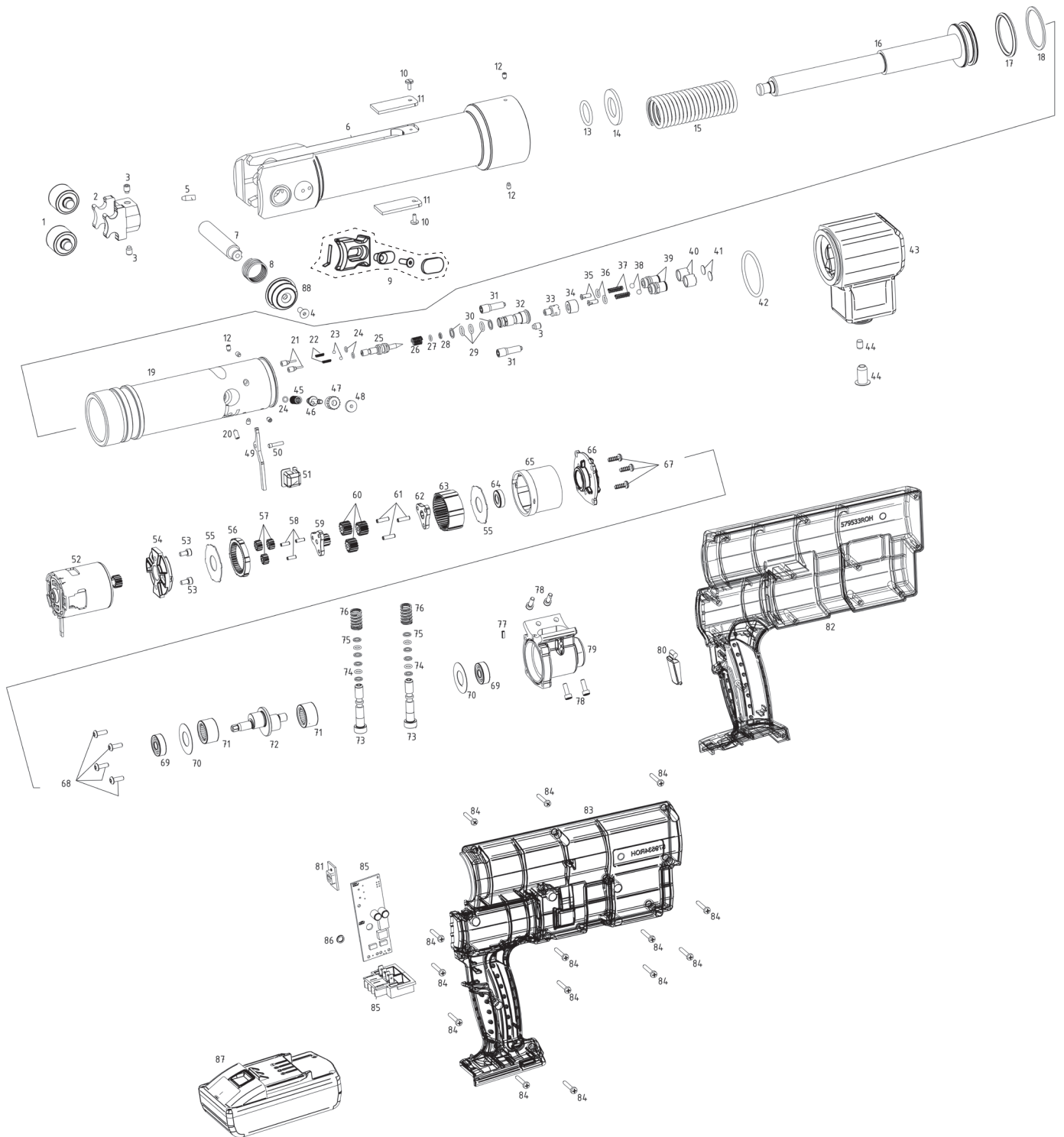

REMS Akku-Press XL 45kN 22V ACC

	deu	eng	fra	ita	
—	Rollenträger kompl. XL Pos. 1–3	Roller holder compl. XL Pos. 1–3	Support galets compl. XL Pos. 1–3	Portarulli compl. XL Pos. 1–3	579557 R
—	Antriebsgehäuse + Verriegelung Akku-Press XL 45kN Pos. 5–13	Drive housing + locking Akku-Press XL 45kN Pos. 5–13	Carcasse + verrouillage Akku-Press XL 45kN Pos. 5–13	Carcassa ingranaggio Akku-Press XL 45kN Pos. 5–13	579555 R
9	Presszangenverriegelung mit Pos. 88	Tongs lock with Pos. 88	Verrouillage avec Pos. 88	Perno fissaggio pinza con Pos. 88	571299R
—	Vorschubkolben kompl. Akku-Press XL 45kN Pos. 14–18	Feed piston compl. Akku-Press XL 45kN Pos. 14–18	Piston d'avance compl. Akku-Press XL 45kN Pos. 14–18	Pistone d'avanzamento compl. Akku-Press XL 45kN Pos. 14–18	579556 R
15	Druckfeder	Pressure spring	Ressort de compression	Molla di compressione	579226R
—	Ringsatz Akku-Press XL 45kN Pos. 17, 18, 74, 75	Ring set Akku-Press XL 45kN Pos. 17, 18, 74, 75	Jeu de joints Akku-Press XL 45kN Pos. 17, 18, 74, 75	Set anelli Akku-Press XL 45kN Pos. 17, 18, 74, 75	579539 R
—	Hydraulikblock kompl. XL 45kN, Pos. 19–48	Hydraulic block compl. XL 45kN, Pos. 19–48	Bloc hydraulique compl. XL 45kN, Pos. 19–48	Blocco idraulico compl. XL 45kN, Pos. 19–48	579540 R
42	O-Ring	Locking ring	Joint torique	Guarnizione O-Ring	060386
43	Ausgleichsbehälter	Compensating reservoir	Reservoir de compensation	Contentitore di compensazione	579542 ROH
44	Stopfen mit Stabmagnet	Plug with magnet	Bouchon avec magnet	Tappo con calamita	571249 R
49	Hebel XL 45kN	Lever XL 45kN	Levier XL 45kN	Leva XL 45kN	579251 R
50	Stift	Pin	Goupille	Perno	579254 R
51	Betätigungsknopf XL 45kN	Actuating button XL 45kN	Bouton d'actionnement XL 45kN	Pulsante d'azionamento XL 45kN	579252 ROH
52	Gleichstrommotor mit Ritzel	D.C. Motor with pinion	Moteur à courant continu avec pignon	Motore monofasico con pignone	576116 R22
—	Planetengetriebe kompl. Pos. 54–65	Planetary gear drive compl. Pos. 54–65	Engranaage planetaire compl. Pos. 54–65	Ingranaggio planetario compl. Pos. 54–65	576330 R
53	Zylinderschraube	Fillister head screw	Vis tête cylindrique	Vite a testa cilindrica	081001
54	Motorflansch	Motor flange	Flasque du moteur	Flangia motore	576151 ROH
—	Pumpe kompl. Akku-Press XL 45kN Pos. 68–72 , 77–79	Pump compl. Akku-Press XL 45kN Pos. 68–72 , 77–79	Pompe compl. Akku-Press XL 45kN Pos. 68–72 , 77–79	Pompa compl. Akku-Press XL 45kN Pos. 68–72 , 77–79	579558 R
66	Getriebeflansch XL 45kN	Gear flange XL 45kN	Flasque d'engrenage XL 45kN	Flangia del ingranaggio XL 45kN	579543 ROH
67	PT-Linsenschraube	PT fillister head screw	Vis tête fraisée bombée PT	PT vite a testa svasata con perno	083048
—	Pumpenkolben kompl. Akku-Press XL 45kN Pos. 73–76	Pump piston compl. Akku-Press XL 45kN Pos. 73–76	Piston de pompe compl. Akku-Press XL 45kN Pos. 73–76	Pistone a pompa compl. Akku-Press XL 45kN Pos. 73–76	579559 R
—	Schalter Akku-Press XL 45kN Pos. 85–86 , 81	Switch Akku-Press XL 45kN Pos. 85–86 , 81	Interrupteur Akku-Press XL 45kN Pos. 85–86 , 81	Interruttore Akku-Press XL 45kN Pos. 85–86 , 81	579538 R22
80	Taste	Button	Bouton	Pulsante	576148 ROH
—	Gehäuseschalen Li-Ion, Paar Akku-Press XL 45kN Pos. 82–83	Housing shells Li-Ion, pair Akku-Press XL 45kN Pos. 82–83	Coquille carcasse Li-Ion, paire Akku-Press XL 45kN Pos. 82–83	Calotta carcassa Li-Ion, paio Akku-Press XL 45kN Pos. 82–83	579532 R
84	Blechschaube	Sheet metal screw	Vis à tôle	Vite da lamiera	083064
87	Akku-Li-Ion 21,6V, 5,0Ah	Battery Li-Ion 21.6V, 5.0Ah	Accu Li-Ion 21,6V, 5,0Ah	Batteria Li-Ion 21,6V, 5,0Ah	571581 R22
88	Knopf	Button	Bouton	Pulsante	571254PLX